

# Manual

Encoders with  
PROFIBUS interface

# Table of Contents

<b>1</b>	<b>Document</b> .....	<b>4</b>
<b>2</b>	<b>General Information</b> .....	<b>5</b>
2.1	Target Group.....	5
2.2	Symbols used / Warnings and Safety instructions .....	5
<b>3</b>	<b>Product Description</b> .....	<b>7</b>
3.1	Technical Data Sendix 58xx .....	7
3.2	Technical Data Sendix 70xx .....	8
3.3	PROFIBUS Interface Description.....	9
3.4	Supported Standards and Protocols .....	10
<b>4</b>	<b>Installation</b> .....	<b>11</b>
4.1	Electrical Installation .....	11
4.1.1	General Information for the Connection .....	11
4.1.2	Terminal Assignment 58xx.....	11
4.1.3	Terminal Assignment 70xx.....	13
4.1.4	Termination .....	14
4.1.5	Network Topology .....	15
<b>5</b>	<b>Commissioning and Operation</b> .....	<b>16</b>
5.1	Function and Status LED .....	16
5.2	Quick Start Guide.....	17
5.2.1	Default Settings.....	17
5.2.2	Configuring the Modules .....	19
5.3	Protocol Features.....	22
5.3.1	Device Profile V1.1.....	22
5.3.2	The Requirements Profile .....	22
5.3.3	Slave Mode .....	23
5.3.4	Encoder Start-up Phase on the PROFIBUS .....	23
5.3.5	Configuration and Parameterizing .....	23
5.3.6	Protective Functions.....	23
5.4	Configuration Parameters Description .....	24
5.4.1	Modules.....	24
5.4.2	Speed.....	28
5.4.3	Station Address.....	29
5.4.4	Scaling .....	30
5.4.5	Preset.....	31
5.5	Examples .....	32
5.5.1	Changing the Station Address with SSA.....	32
5.5.2	Performing a Preset.....	34
<b>6</b>	<b>Annex</b> .....	<b>36</b>
6.1	Extended Diagnostic .....	36
6.2	Service Access Point (SAP).....	37

---

6.3	Decimal / Hexadecimal conversion table .....	38
	<b>Glossary .....</b>	<b>40</b>

# 1 Document

This document is the English translation of the original German version.

## **Legal notices**

All of the contents of this document are protected by the rights of use and copyrights. Any duplication, modification, further use and publications in other electronic or printed media, as well as their publication in the Internet, even partially, is subject to the previous written authorization.

The brand names and product brands mentioned in this document are trademarks or registered trademarks of the respective titleholders.

Subject to errors and changes. The stated product features and technical data shall not constitute any guarantee declaration.

## 2 General Information





Please read this document carefully before working with the product, mounting it or starting it up.

### 2.1 Target Group

The device may only be planned, mounted, commissioned and serviced by persons having the following qualifications and fulfilling the following conditions:

- Technical training.
- Briefing in the relevant safety guidelines.
- Constant access to this documentation.
- In case of electrical equipment for potentially explosive atmospheres, the specialized personnel needs knowledge about the ignition protection category concept.
- For facilities in potentially explosive atmospheres, the authorized person must comply with the applicable country-specific regulations.

### 2.2 Symbols used / Warnings and Safety instructions

 <b>DANGER</b>	<p><b>Classification:</b></p> <p>This symbol, together with the signal word <b>DANGER</b>, warns against immediately imminent threat to life and health of persons.</p> <p>The non-compliance with this safety instruction will lead to death or severe adverse health effects.</p>
 <b>WARNING</b>	<p><b>Classification:</b></p> <p>This symbol, together with the signal word <b>WARNING</b>, warns against a potential danger to life and health of persons.</p> <p>The non-compliance with this safety instruction may lead to death or severe adverse health effects.</p>
 <b>CAUTION</b>	<p><b>Classification:</b></p> <p>This symbol, together with the signal word <b>CAUTION</b>, warns against a potential danger for the health of persons.</p> <p>The non-compliance with this safety instruction may lead to slight or minor adverse health effects.</p>
<b>ATTENTION</b>	<p><b>Classification:</b></p> <p>The non-compliance with the <b>ATTENTION</b> note may lead to material damage.</p>

<b>NOTICE</b>	<b>Classification:</b>
	Additional information relating to the operation of the product, and hints and recommendations for efficient and trouble-free operation.

## 3 Product Description

### 3.1 Technical Data Sendix 58xx

Singleturn technology	Optical
Multiturn technology	Optical, mechanical gear
Singleturn resolution (MUR)	Max. 16 bits (default 13 bits)
Multiturn resolution (NDR)	Max. 12 bits
Multiturn resolution (TMR)	Max. 28 bits (default 25 bits)
Accuracy	$\pm 0.0117^\circ$ (over the whole temperature range)
Data up-to-dateness	5 ms

#### Mechanical characteristics for the Sendix 58xx encoders

Maximum rotary speed IP65 up to 70°C	9000 min <sup>-1</sup> , 7000 min <sup>-1</sup> (continuous operation)
IP65 up to Tmax	7000 min <sup>-1</sup> , 4000 min <sup>-1</sup> (continuous operation)
IP67 up to 70°C	8000 min <sup>-1</sup> , 6000 min <sup>-1</sup> (continuous operation)
IP67 up to Tmax	6000 min <sup>-1</sup> , 3000 min <sup>-1</sup> (continuous operation)
Starting torque (at 20°C) IP65 IP67	< 0.01 Nm < 0.05 Nm
Mass moment of inertia Shaft version Hollow shaft version	3,0 x 10 <sup>-6</sup> kgm <sup>2</sup> 7,5 x 10 <sup>-6</sup> kgm <sup>2</sup> (MT) 6 x 10 <sup>-6</sup> kgm <sup>2</sup> (ST)
Permissible shaft load radial axial	80 N 40 N
Protection level acc. to EN 60529 Housing side Shaft side	IP67 IP65, optional IP67
Working temperature range	-40°C ... +80°C
Materials Shaft/hollow shaft Flange Housing	Stainless steel Aluminum Die-cast zinc
Shock resistance according to EN 60068-2-27	2500 m/s <sup>2</sup> , 6 ms
Vibration resistance according to EN 60068-2-6	100 m/s <sup>2</sup> , 55 ... 2000 Hz

**Electrical data for the Sendix 58xx encoders**

Supply voltage	10 ... 30 V DC
Current consumption (no load) 10 ... 30 V DC	max. 110 mA
Supply voltage reverse polarity protection	Yes
Interface PROFIBUS	PROFIBUS DP V0 Encoder profile Class 2 Encoder profile 3062 V1.1
Resolution Singleturn (MUR) Multiturn (NDR) Total resolution (TMR)	Max. 28 bits (default 25 bits) Max. 12 bits Max. 28 bits (default 25 bits)
Type of connection	3 x M12 connector

**3.2 Technical Data Sendix 70xx**

Singleturn technology	Optical
Multiturn technology	Optical, mechanical gear
Singleturn resolution (MUR)	Max. 16 bits (default 13 bits)
Multiturn resolution (NDR)	Max. 12 bits
Multiturn resolution (TMR)	Max. 28 bits (default 25 bits)
Accuracy	$\pm 0.0117^\circ$ (over the whole temperature range)
Data up-to-dateness	5 ms

**Mechanical data for Sendix 70xx**

Maximum rotational speed	6000 min <sup>-1</sup>
Maximum angular acceleration	5x10 <sup>5</sup> rad/s <sup>2</sup>
Operating/storage and transport temperature range	-40°C ... +60°C [-40°F ... 140°F]
Protection level according to EN 60529	IP67
Protection level according to NEMA 250	Type 6
Installation height	< 2000 m [6562 ft]
Shock resistance according to EN / IEC 60068-2-27	500 m/s <sup>2</sup> , 11 ms
Vibration resistance according to EN / IEC 60068-2-6	5 ... 2000 Hz, 200 m/s <sup>2</sup>



**Electrical data for the Sendix 70xx encoders**

Supply voltage (depending on the variant)	5 V DC 5 ... 30 V DC 10 ... 30 V DC
Current consumption (no load) 5 V DC 5 ... 30 V DC 10 ... 30 V DC	max. 90 mA max. 100 mA max. 100 mA
Protection class according to EN 61140	III (PELV)

**EMC - Electromagnetic Compatibility**

Relevant Standards	EN 55011 Class B:2009 / A1:2010 EN 61326-1:2013
--------------------	--

Kübler tested the conformity of the system on a typical construction with a motor size 80. System responsibility lies with the motor/system manufacturer.

Interface PROFIBUS	PROFIBUS DP V0 Encoder profile Class 2 Encoder profile 3062 V1.1
Resolution Singleturn (MUR) Multiturn (NDR) Total resolution (TMR)	Max. 16 bits (default 13 bits) Max. 12 bits Max. 28 bits (default 25 bits)
Type of connection	3 x M12 connector

**3.3 PROFIBUS Interface Description**

The main task of PROFIBUS DP is the cyclic transmission of process data from the control system to the peripheral devices and vice versa. The access procedure uses the master-slave principle. In polling operation, the master serves the slave devices assigned to it one after the other.

Data exchange is initiated by a query telegram and ended by an acknowledgment telegram from the addressed slave. Thus every slave becomes active only upon request from the master. This prevents simultaneous bus access. The hybrid access method of PROFIBUS allows combined operation of several bus masters or mixed operation of PROFIBUS DP and PROFIBUS FMS within a bus section.

Prerequisite for this is, however, the proper configuration of the bus system and the unambiguous allocation of the slave devices to the masters. PROFIBUS DP distinguishes two master types:

**Class 1 master (DPM1):** generally the automation system (PLC). It is in charge of the cyclic transmission of the operating data and makes the user data available. The Class 1 master can be addressed by a class 2 master that uses determined functions such as e. g. read or write services via an initiate service.

**Class 2 master (DPM2):** the engineering tool that exclusively performs acyclic data transmission. The communication on the bus is based on whether a class 1 master or a class 2 master initiates the communication.

<b>NOTICE</b>	<b>Direct access to the slaves is not allowed.</b>
	The functions are limited to slave support services such as e.g. the readout of diagnostic information. Therefore, a class 2 master is understood as a programming or diagnostic device.

### 3.4 Supported Standards and Protocols

	<b>Class 1 Resolution 16 bits (typ. singleturn)</b>	<b>Class 2 Resolution 32 bits (typ. multiturn)</b>
In/output consistent	The encoder uses 1 input word and 1 output word, which are respectively consistently transmitted via the bus.	The encoder uses 2 input words and 2 output words, which are respectively consistently transmitted via the bus.
Input consistent	The encoder uses 1 input word, which is consistently transmitted via the bus.	The encoder uses 2 input words, which are respectively consistently transmitted via the bus.

For commissioning, the device requires the corresponding GSD data:

<b>Version</b>	<b>Series</b>	<b>GSD file</b>
Singleturn	5858	KUEB5868ST.gsd
	5878	KUEB5868ST.gsd
	7058	KUEB7058.gsd
	7078	KUEB7058.gsd
	7158	KUEB7158.gsd
	7178	KUEB7158.gsd
Multiturn	5868	KUEB5868.gsd
	5888	KUEB5868.gsd
	7068	KUEB7068.gsd
	7088	KUEB7068.gsd
	7168	KUEB7168.gsd
	7188	KUEB7168.gsd

## 4 Installation

### 4.1 Electrical Installation

#### 4.1.1 General Information for the Connection

<b>ATTENTION</b>	<p><b>Destruction of the device</b></p> <p>Before connecting or disconnecting the signal cable, always disconnect the power supply and secure it against switching on again.</p>
<b>NOTICE</b>	<p><b>General safety instructions</b></p> <p>Make sure that the whole plant remains switched off during the electrical installation.</p> <ul style="list-style-type: none"> <li>• Make sure that the operating voltage is switched on or off simultaneously for the device and the downstream device.</li> </ul>
<b>NOTICE</b>	<p><b>Traction relief</b></p> <p>Always mount all cables with traction relief.</p>
<b>NOTICE</b>	<p><b>Interference susceptibility</b></p> <p>Proceed as follows:</p> <ul style="list-style-type: none"> <li>• Connect the shield to the device housing.</li> <li>• Comply with the maximum cable length for stub lines and for the total length of the bus network.</li> <li>• Check the maximum supply voltage on the device.</li> </ul>
<b>ATTENTION</b>	<p><b>Wear of the memory module</b></p> <p>Avoid too frequent writing of the EEPROM. It is used e.g. when setting a preset value. The memory module is designed for approximately 500,000 write cycles. If the maximum number of write cycles is exceeded, single memory areas may be damaged and errors may occur.</p>

#### 4.1.2 Terminal Assignment 58xx

PROFIBUS connection M12 connector

Interface	Type of connection	Cable (isolate unused wires individually before commissioning)	Connector					
3	2	<b>Connector</b>						
		Bus IN						
		Signal	–	PB_A	–	PB_B		Shield
		Pin	1	2	3	4		5
		Bus OUT						
		Signal	BUS_VDC	PB_A	BUS_GND	PB_B		Shield
		Pin	1	2	3	4		5
		Voltage supply						
		Signal	+V	–	0 V	–		
Pin	1	2	3	4				
3	1	<b>Terminal strip</b>						
		Bus IN						
		Signal	B	A	0 V	+ V		
		Pin	1	2	3	4		
		Bus OUT						
		Signal	B	A	0 V	+ V		
Pin	7	8	5	6				

### PROFIBUS connection internal terminal strip

<b>NOTICE</b>	<p><b>Bus connection with separate voltage supply and PG screwed fitting.</b></p> <p>The bus cover must be removed to access to the internal terminal strip.</p> <ul style="list-style-type: none"> <li>• Unscrew the two bus cover screws and remove the bus cover from the encoder.</li> <li>• When re-tightening, take care to tighten the screws with a torque of 0.5 Nm.</li> </ul>
---------------	--

Proceed as follows to connect the terminal strip :

- Guide the incoming bus cable through the left screwed cable fitting and
- connect the bus cable to **terminal (B) and terminal (A)**. Apply the cable shield on the cable fitting.
- If there are further devices in the bus strand : Guide the continuing cable through the right screwed cable fitting and connect it to **terminal (B) and terminal (A)**.

### Supply voltage

- Guide the encoder supply voltage through the central screwed cable fitting and connect it to the left **terminals (+V) and terminal (0 V)**.
- Apply the cable shield on the cable fitting.

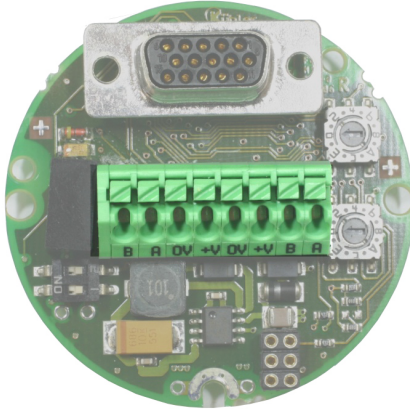

103389963

<b>NOTICE</b>	<b>Duplicated signals</b>
	All signal inputs/outputs are duplicated and connected internally.

Abbreviation	Designation	Direction
B	Profibus	Out
A	Profibus	Out
0V	0 volt supply	Out
+V	+UB supply	Out
0V	0 volt supply	In
+V	+UB supply	In
B	Profibus	In
A	Profibus	In

#### 4.1.3 Terminal Assignment 70xx

Cable									
Signal	0 V	+V	PB_A IN	PB_B IN	BUS_ GND	BUS_ VDC	PB_A OUT	PB_B OUT	⏏
Wire la- beling	1	2	4	5	6	7	8	9	Shield

### 4.1.4 Termination

If a device is the last participant on the bus, the looped-through PROFIBUS must be terminated actively at both ends with a bus termination resistor between A and B. For closed devices, the termination must be specified in the order or provided by means of an external resistor. For good signal transmission, PROFIBUS segments must be terminated with a bus termination. For PROFIBUS RS485, the bus termination consists of three resistors.

The bus termination can be activated in the device or is prepared in the switch. If more than 32 participants are connected to the bus, repeaters must be used to connect the single bus segments. The terminating resistors between the lines are generally  $220 \Omega$ .  $390 \Omega$  resistors are used between the reference potentials. Generally, the line termination is located in the cables or in the respective PROFIBUS device, but it can also be installed separately. Network Topology [► 15]

#### Cable termination

Every bus segment must be terminated at both ends with a termination resistor. This cable termination is integrated in the RS485 repeaters, in the bus terminals and in the bus connectors, and it can, if necessary, be activated. The component must be powered before the cable termination can be activated. The RS485 repeaters and the termination have their own power supply.

The RS485 transmission technology allows connecting at the maximum 32 devices per bus segment (DTE's and Repeaters).

The maximum permissible cable length depends on the transmission speed and on the used LAN cable. Network Topology [► 15]

#### 4.1.4.1 Termination with Sendix 58xx

The bus termination is set via hardware with the **two DIP switches** on the bus cover of the encoder rear side.

Both switches on: Termination active

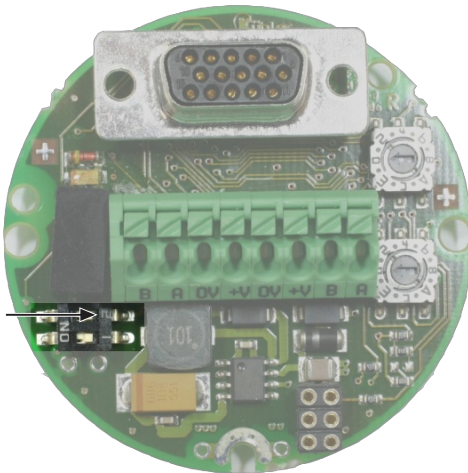

90154891

**NOTICE****Bus termination with closed devices**

For closed devices, the termination is either activated at the factory or it must be provided externally with a resistor.

- Connect the terminating resistors with wires 8 and 9 (BUS\_A) and (BUS\_B), and, for the active current lines, with wires 6 and 7.

### 4.1.5 Network Topology

All devices are connected in a bus structure (line). Up to 32 participants (master or slaves) can be connected together in a segment. The bus is terminated with an active bus termination (termination resistors) at the beginning and at the end of every segment.

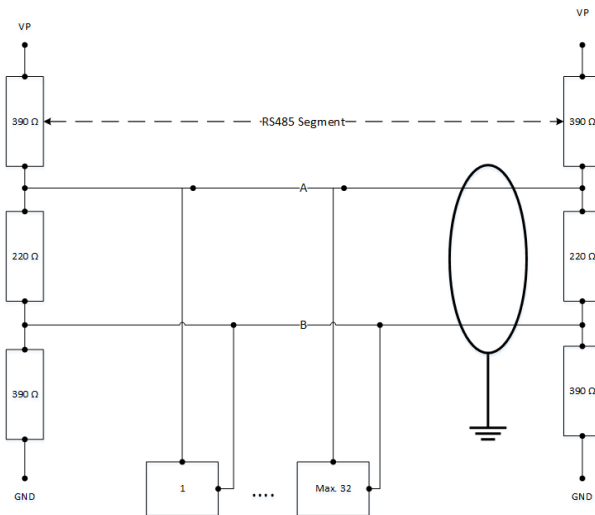

111511819

Both bus terminations must always be powered to ensure trouble-free operation. Termination [► 14]





The maximum line length depends on the transmission speed. The indicated line length can be extended by using repeaters. We recommend not to use more than 3 repeaters.

Baud rate [kBit/s]	9.6	19.2	93.75	187.5	500	1500	12000
Range/segment	1,200 m	1,200 m	1,200 m	1,000 m	400 m	200 m	100 m



## 5 Commissioning and Operation

### 5.1 Function and Status LED

- Red LED = DIAG
- Yellow LED = BUS
- Green LED = PWR





Display	LED	Meaning	Error cause	Addition
PWR off		No bus voltage present	No voltage on the device Power supply defective	Check the voltage supply
PWR on		Bus voltage present Device ready for operation	Device in configuration mode	
BUS off		Device waiting for configuration or parameterizing	GSD module must be loaded and sent to the encode	Observe the combination with the DIAG LED.
BUS on		Connection to the master established DATA_Exchange mode		Process data exchange

#### LED combinations during operation

Display	LED	Meaning	Error cause	Addition
PWR +BUS on		DATA_Exchange mode		Device ready for position data exchange
Diag flashing		Red LED flashing	Temperature overrun Sensor monitoring Single-step error Sensor LED current monitoring	Connection to the master when connecting + additional error cause (Diagnostic header requested)



**Error display after powering**

Display	LED	Meaning	Error cause	Addition
PWR +Diag flashing	 	Red LED flashing 1 x briefly Pause 1.6 sec.	Data connection with sensor faulty Sensor faulty	Device must be sent back to manufacturer for check
PWR +Diag flashing	 	Red LED flashing 2 x briefly Pause 1.6 sec.	Wrong node address Profibus short-circuit Termination faulty	Check Profibus

**General RESET - Switching the device on while pressing the SET key**

Display	LED	Meaning	Error cause	Addition
PWR +Diag flashing		Short flashing of the red LED	Diagnostic mode	Device ready for dia- gnostic

## 5.2 Quick Start Guide

### 5.2.1 Default Settings

Before a PROFIBUS DP system can be started up, all connected participants, including the master system, must be assigned unique bus addresses. Only this way will an unambiguous addressing be ensured on the bus. The addresses of the stations must first be assigned via the bus.

The physical system settings then follow through the parameters set of the master. Besides the master bus address, this set includes e. g. the baud rate, the timeout times and the number of transmission repetitions. In addition to the master parameters set, a slave parameters set must be saved for every slave to be activated. A data set contains the parameter assignment and configuration data of the slave and the address pointer for the logical storage of the I/O data. When the parameter sets are present, the master system begins to start up the slaves one after the other, either upon user request or automatically.

The first so-called diagnostic cycles show which slave is present on the bus. Only the slaves that send a proper feedback during the diagnostic cycle are subsequently parameterized during the parameterizing cycles with the corresponding data stored in the master. After error-free execution, the configuration cycles compare the required configuration stored in the master with the actual configuration of the slaves. After the last diagnostic cycle, every slave that did not detect any error during the comparison is ready for operation.

Each of these slaves is automatically integrated by the master in the operating data exchange. For diagnostic purposes, the master provides a diagnostic buffer for every slave. This buffer can be read out by the user for other purposes. To make diagnostic easier, a group diagnostic field is kept simultaneously. This field shows bit by bit whether it holds diagnostic data for a slave or not.

The following parameters are factory-set:

Designation	Default	Switch	Product
Baud rate	Automatic	Not available	
Node address	63 – without SSA	Switch setting 0x3F	Sendix 58xx
	125 - with SSA	For devices without removable bus cover setting 0xFF (node address via software change See Set Slave Address (SSA) [▶ 30].	Sendix 70xx
Termination	Off	Switch setting off	Sendix 58xx

Name	Default	Byte	Bit
Code sequence	0 = CW	9	0
Class 2 functionality	1 = Class 2 on	9	1
Scaling	1 = Scaling on	9	3
Scaling type	0 = standard (MUR + TMR)	9	7
Scaling parameter MUR	MUR = 8192 (13 bits)	10 ... 13	0 ... 7
Scaling parameter TMR	TMR = 33554432 (25 bits)	14 ... 17	0 ... 7

**Resetting to factory settings**

The original standard values (**default values at delivery**) can be reset by pressing the SET key on the rear side when switching on (parameters restoration).



NOTICE	Reset via the SET key
	<p>Note that, for devices with external SET key, all programmed parameters are lost (except the station address, which has been assigned by SSA). See Set Slave Address (SSA) [▶ 30].</p> <p>A reset with the SET key is only possible for devices with external SET key.</p>

Performing an external position reset:

- a) Switch the encoder off.
  - b) When switching it back on, hold the SET key pressed for about 3 seconds, until the **DIAG LED** flashes.
  - c) Switch the device off again.
- ⇒ When switching it on again, all values will be reset to the default settings.

If errors occurred during the programming of the objects, and if these parameters are saved in the EPROM, addressing the encoder will not be possible when switching it on the next time. This error can only be corrected by a general **Reset** of the encoder.

#### Also refer to

- 📖 Extended Diagnostic [▶ 36]

## 5.2.2 Configuring the Modules

To be able to perform a general parameterizing of the device, the corresponding GSD file must be selected and implemented first (e. g. **KUEB7068.GSD**). It can be found on the Kübler web page of the concerned product.

The respective software allows including the GSD files.

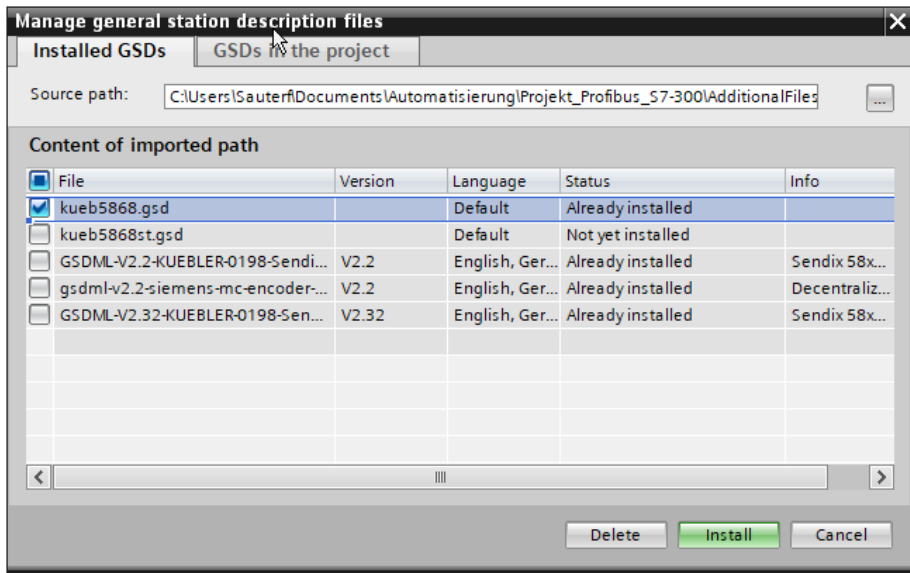

Then a **Module** of the GSD file must be selected for the configuration.

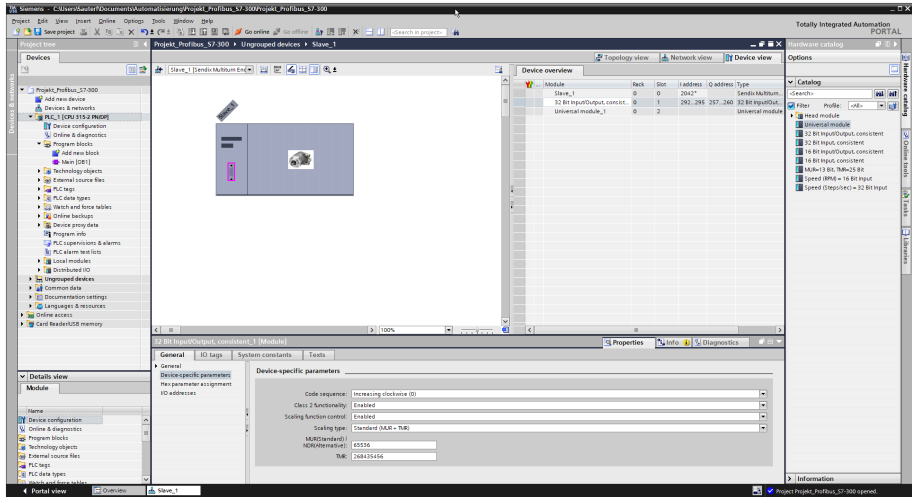

8 different modules are available :

- Universal module
- 32-bit input/output, consistent
- 32-bit input, consistent
- 16-bit input/output, consistent
- 16-bit input, consistent
- MUR = 13 bits and TMR = 25 bits (input/output, consistent)
- Rotational speed (RPM) 16 bits
- Speed (units/s) 32 bits

The modules describe the structure of the input and output data. Input data is data sent by the encoder. Output data is sent from the control to the encoder. At the maximum 2 modules can be used simultaneously.

**The following input words can be combined:**

- Resolution 32 bits, input consistent + Resolution 16 bits Speed in (units/s)
- Resolution 16 bits, input consistent + Resolution 32 bits Rotational speed in (rpm)

The modules (except for the 25-bit configuration) allow defining the following :

- **Code sequence (byte 9, bit 0)**
  - 0 = clockwise
  - 1 = counter-clockwise
- **Class 2 functionality (byte 9, bit 1)**
  - 0 = no
  - 1 = yes

- **Scaling release (byte 9, bit 3)**
  - 0 = no
  - 1 = yes
- **Scaling type (byte 9, bit 7)**
  - 0 = standard (MUR + TMR)
  - 1 = alternative (NDR + TMR)
- **Scaling parameter MUR or NDR (bytes 10-13)**
  - MUR = Measuring Units per Revolution
  - NDR = Number of Distinguished Revolutions
- **Scaling parameter TMR (bytes 14-17)**
  - TMR = Total Measuring Range

### 5.2.2.1 External Preset

The device can perform a preset with the integrated **SET Key**. The **Position** resulting from this is 0.



90096011

The **Offset** between the physical zero position of the disk and the electronic zero point resulting from this can be queried through the extended diagnostic header.

Performing an external preset

- a) Press the SET key on the cover of the device.
  - ⇒ The device outputs a diag message. The red LED flashes
  - ⇒ The current position is reset to 0.

### Also refer to

- 📖 Set Slave Address (SSA) [▶ 30]

## 5.3 Protocol Features

### 5.3.1 Device Profile V1.1

This profile describes a manufacturer-independent and binding specification of the interface for encoders. The protocol defines which Profibus functions are used and how they are used. This standard allows for an open and manufacturer-independent bus system.

The device profile is subdivided in two object classes:

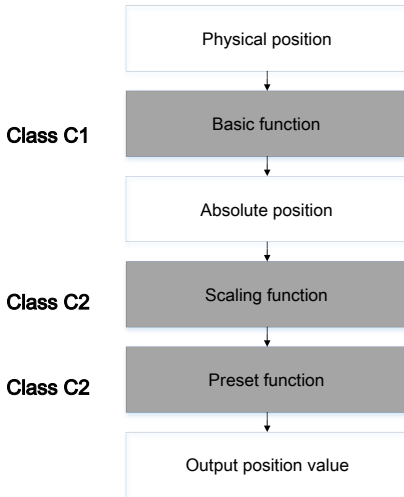

114716171

- **Class C1** describes all basic functions the encoder is to offer.
- **Class C2** includes a wide range of extended functions, which have to be supported by the encoders of this class (mandatory) or which are optional. So devices of class C2 include all C1 and mandatory C2 functions, as well as further manufacturer-specific optional functions. Moreover, an address range, which can receive manufacturer-specific special functions, is defined in the profile.

### 5.3.2 The Requirements Profile

The connection between the decentralized process flow and the central control through the communication system takes place at the lowest hierarchical level via the field or process bus. At this level, the main requirements are a simple protocol procedure and short data transmission times for the communication.

This ensures the shortest system response time possible to the dynamic states of the peripheral devices. Besides the classical data exchange, the acyclic transmission of parameter, diagnostic and configuration data must be possible too without fundamentally affecting the real-time capability of the bus. This is the only way to ensure a good diagnostic and safe operation.

### 5.3.3 Slave Mode

This description contains information about the implementation of the PROFIBUS DP transmission protocol in the slave mode on our devices. The scope of the described functions can be limited according to the device or to the application. In particular, less functions are generally used in the event of protocol conversions.

### 5.3.4 Encoder Start-up Phase on the PROFIBUS

When starting up, the encoder is in the BAUD SEARCH state. After having detected the baud rate, it switches to the WAIT\_PRM state and waits for the parameterizing data from the DP master. Parameterizing takes place automatically when the DP master starts.

The following parameters are transmitted to the encoder: Counting direction and measuring length in steps (for more information, see encoder profile of PNO).

After successful transmission of the correct parameterizing data the encoder switches to the WAIT\_CFG state. The PROFIBUS master sends a configuration byte to determine the number of inputs/outputs. If the configuration byte is correct, the encoder switches to the **DATA\_EXCHANGE** state.

### 5.3.5 Configuration and Parameterizing

Parameterizing, i. e. the transmission of the parameters for counting direction, encoder resolution, etc., generally takes place within the configuration program of the used PROFIBUS master. To this purpose, the type or GSD file (device file) must be copied in the directory for the type or GSD files. With programs such as COM PROFIBUS or STEP7 Manager, an update of the internal devices list (hardware catalog) must be performed in the software.

For further information on the integration of field devices, refer to the documentation of the used software.

#### Changing the station address

If the station address needs to be changed, the master must support Class 2. This operation is possible in the start-up phase of the device.

### 5.3.6 Protective Functions

PROFIBUS DP is provided with many protective functions. They ensure safe and error-free communication, not only in the harsh environment of the decentralized peripheral devices, but also in the event of external interferences or failure of one or more participants. Faulty parameterizing is detected directly, since participants with wrong parameters are not integrated in the operating data exchange.

The failure of participants is recorded by the master and displayed for the user with a group diagnostic message. Every failure in the transmission path is detected by the slave by means of time monitoring and leads to the switching off of the outputs.

EMC interferences are almost filtered out through the differential signal of the interference-safe RS485 transmission system.

Errors during data transmission are detected by frame and check sum monitoring and lead to the repetition of the telegram.

## 5.4 Configuration Parameters Description

### 5.4.1 Modules

The configuration program generally provides an input mask (display) for the configuration, i. e. the input of length and I/O type on the PROFIBUS. The identification is already predefined on this display, independently of the target configuration. Only the I/O addresses must be input. Depending on the required configuration, the encoder occupies a different number of input and output words on the PROFIBUS.

The described parameters also depend on the target configuration. The GSD device file (e. g. **KUEB7068.GSD**) contains five target configurations for PNO Class1 and 2, respectively with 16-bit and 32-bit resolution.

The configuration program allows setting sensor parameters such as e.g. the input of the resolution and counting direction data.

Module	Back	Dist.	I address	Q address	Type
Dist. 1	0	0	2047		simatic32bitinputoutput
32 Bit Input/Output consistent	0	1	2048-2057	2058-2067	32 Bit Input/Output consistent
Universal module 1	0	2			Universal module

**Device-specific parameters**

Code sequence: Increasing (clockwise 0°)

Class 2 functionality: Enabled

Scaling function control: Enabled

Scaling type: Standard (MUR = TMR)

MUR (Resolution): 13 bits

TMR (Resolution): 25 bits

Max. (Resolution): 1024 counts

106058379

Modules available for the regular operation of the encoder:

- Universal module
- 32-bit input/output, consistent
- 32-bit input, consistent
- 16-bit input/output, consistent
- 16-bit input, consistent
- MUR = 13 bits and TMR = 25 bits (input/output, consistent)
- Rotational speed (RPM) 16 bits
- Speed (units/s) 32 bits



<b>NOTICE</b>	<b>Combination of modules</b>
	All configurations can be combined with the rotational speed (RPM) 16 bits consistent or the speed (units/s) 32 bits consistent.

Various settings can be performed within the modules. They are done in the input mask of the used program.

**Direction of rotation:**

- Increasing in clockwise direction (0) (CW)
- Increasing in counter-clockwise direction (1) (CCW)

32 Bit Input/Output, consistent

Parameter Name : Code sequence

Text : Increasing clockwise (0)

Value : 0

Data Type : Bit

Lower Limit : 0

Upper Limit : 1

OK Help Cancel

9007199360906507

**Class 2 functionality on**

If scaling is active, class 2 must be switched on.

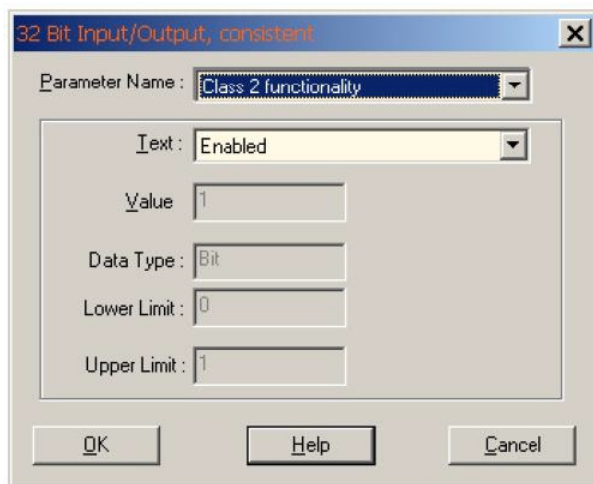

9007199360908171

**Scaling function control on**

When scaling is switched on – the position depends on the MUR and TMR values.

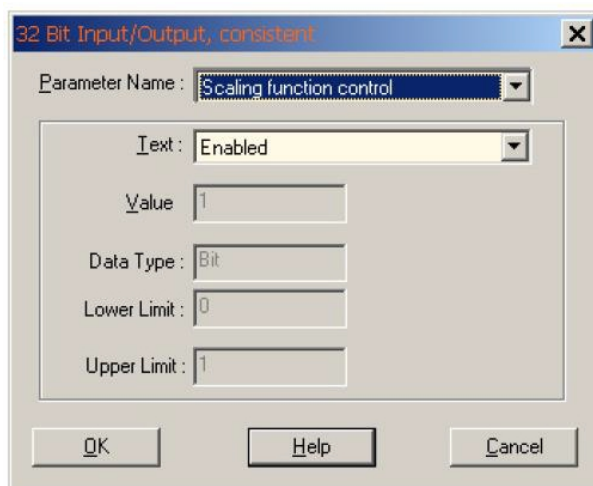

9007199360909835

**Scaling type MUR + TMR**

Scaling type (MUR + TMR)

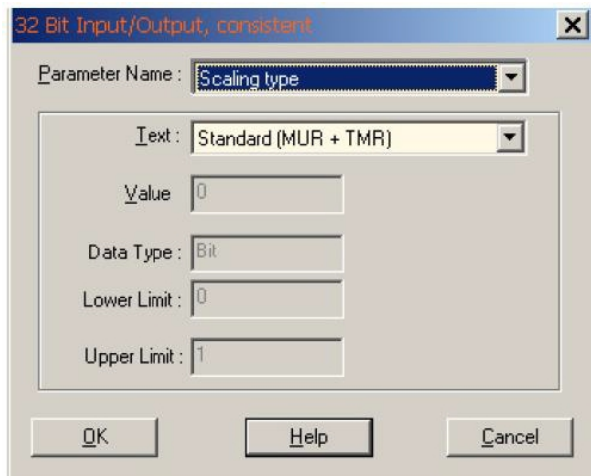

9007199360911499

**Value for resolution per revolution MUR**

Example: 3600 steps per revolution

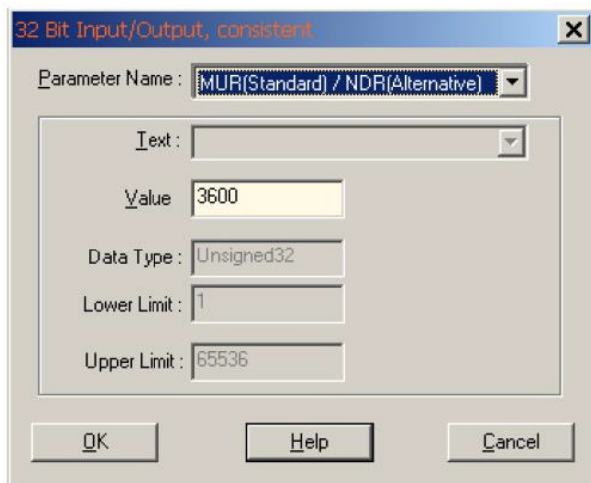

9007199360913163

**Value for total resolution**

Example: Value for total resolution 36000

Position range: 0...36000

Revolutions 10

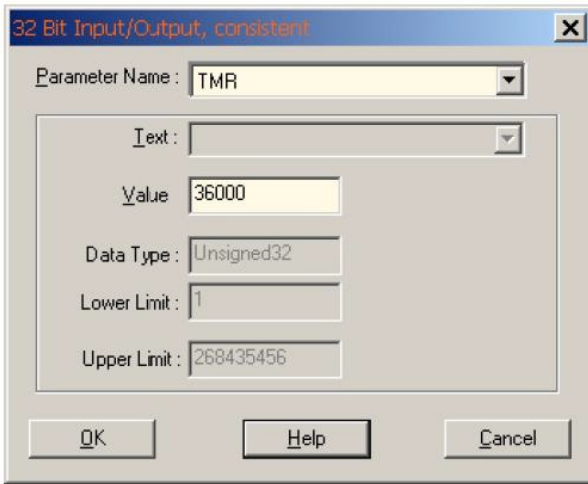

9007199360914827

### 5.4.2 Speed

All modules can be combined with the configuration of an additional speed value. The **input words** are extended, depending on the configuration of the speed value, up to a maximum length of 8 bytes (64 bits). The speed value is signed and depends on the counting direction.

Positive values clockwise, negative values counter-clockwise. Format is "Big Endian":

Input word		Input word		Format	Max.
Byte 0	Byte 1	Byte 2	Byte 3		
		0	0	RPM	0
		17	70	RPM	6000
		E8	90	RPM	-6000
00	63	FF	9C	Unit/s	6553500
FF	9C	00	64	Unit/s	-6553500

#### Rotational speed limitations

<b>NOTICE</b>	<b>Calculation basis for the speed (steps/s).</b>
	The physical singleturn is always assumed as the calculation basis (65536 steps/revolution) when setting the speed (steps/s).

Singleturn encoders:      **600 rpm**            higher rotational speeds produce value ffffh  
 Multiturn encoders:      **12,000 rpm**        higher rotational speeds produce value ffffh

### 5.4.3 Station Address

The station address is set by means of the two address rotary switches. Default address at delivery is 0x3F (63 dec.)

<b>NOTICE</b>	<p><b>Setting the station address (software or hardware side)</b></p> <p>These settings have higher priority than the software setting of the master. With devices without removable bus cover, the default setting is 0xFFh for the software.</p>
---------------	--

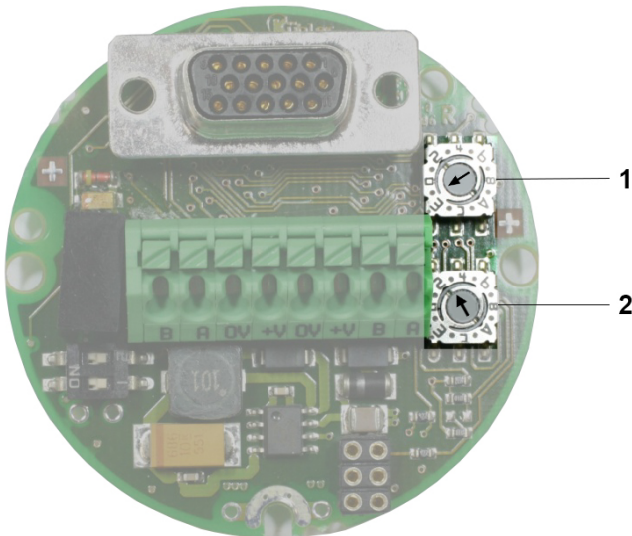

115555851

Switch	Values range	Ex. for address 3F
1	Least significant address rotary switch x1 Values range 1..F *	F
2	Most significant address rotary switch x10 Values range 1..7 *	3

**Station address 0** is reserved and shall not be used for any node. The resulting node numbers are in the range **1...7Dh** hexadecimal (1... 125 decimal).

<b>NOTICE</b>	<b>Taking over a new station address</b>
	A new node number is only taken into consideration at the following booting (Reset/Power-on) of the encoder. All other settings in the objects table remain retained.

### Changing the station address via software (SSA):

If the 2 rotary switches are in **Position Fh**, the node number can also be set with a **Class 2 master** in the Profibus start sequence via the service access point **SAP 55 Set\_Slave\_Address** (SSA). Set Slave Address (SSA) [▶ 30]

#### 5.4.3.1 Set Slave Address (SSA)

SSA allows setting the station addresses by software. To allow this, the 2 rotary switches must be set to **position 0xF**. Default setting after booting is **address 125 (0x7D)**. This allows setting the node number also with a **Class 2 master** in the Profibus start sequence via the service access point **SAP 55 Set\_Slave\_Address**. See Service Access Point (SAP) [▶ 37].

<b>NOTICE</b>	<b>Taking over a new station address</b>
	A new station address is only taken into consideration at the following booting (Reset/Power-on) of the encoder. All other settings in the objects table remain retained.
	The station address is not reset by a reset.
	Only valid addresses are saved in a non-volatile memory and become active.

## 5.4.4 Scaling

Standard scaling scales as follows:

- With MUR and TMR
- One revolution corresponds exactly to MUR = TMR values
- CW code sequence

$$\text{Position}_{\text{scaled}} = ((\text{Position}_{\text{unscaled}} / \text{Singleturn resolution}) * \text{MUR}) \% \text{TMR}$$

<b>NOTICE</b>	<b>Pay attention to the division factor</b>
	For the scaled total position (TMR), make sure that the programmed value is always an integer divisor of total resolution GP_U.
	This formula shows that an exact positioning beyond the range limits only is possible if the division factor TMR/MUR is an integral multiple. Otherwise, position errors will occur below 0 and above the maximum range.

**Alternative scaling scales as follows:**

- With NDR and TMR
- NDR revolutions correspond exactly to the TMR values
- CW code sequence

$$\text{Position}_{\text{scaled}} = ((\text{Position}_{\text{unscaled}} / (\text{NDR} * \text{Singleturn resolution})) * \text{TMR}) \% \text{TMR}$$

**5.4.5 Preset**

In the 'Class 2' mode, the encoder can be preset via PROFIBUS to any position value within the values range of 27 bits or 15 bits. This is done by **setting the most significant bit (MSB) of the output data** (4 bytes for Class 2 configuration - 32 bits or 2 bytes for Class 1 configuration - 16 bits).

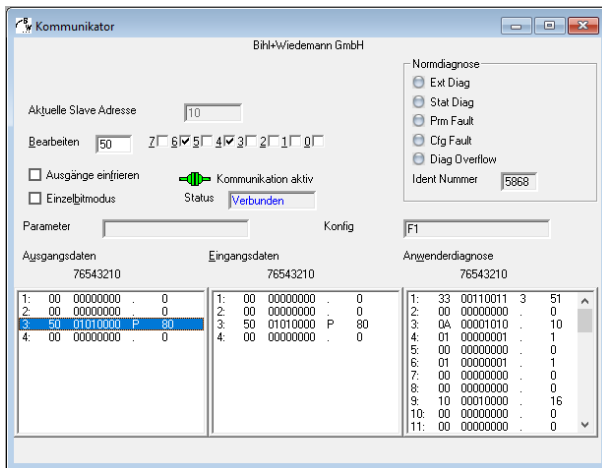

106050699

The preset value transmitted in data bytes 0 - 3 is taken over with the rising edge of bit 32 (= bit 7 of data byte 3) as the position value. The encoder goes on counting from this position. A new setting is only possible after the control bit has been reset. This operation is not confirmed via the inputs.

**NOTICE****Warning message when performing the preset.**

When performing the preset, the device issues a warning message, since the position can change suddenly by a large value. This is an intentional behavior and not an error.

## 5.5 Examples

### 5.5.1 Changing the Station Address with SSA

<b>NOTICE</b>	<b>Use of SSA</b>
	The use of SSA is mainly suitable for devices without removable bus cover.

- ✓ Example of a software change of the station address for devices with removable bus cover.  
(The following example uses a PROFIBUS master tool for parameterizing.)
- a) Remove the bus cover and set the rotary switches to position 0xFF (255 decimal).

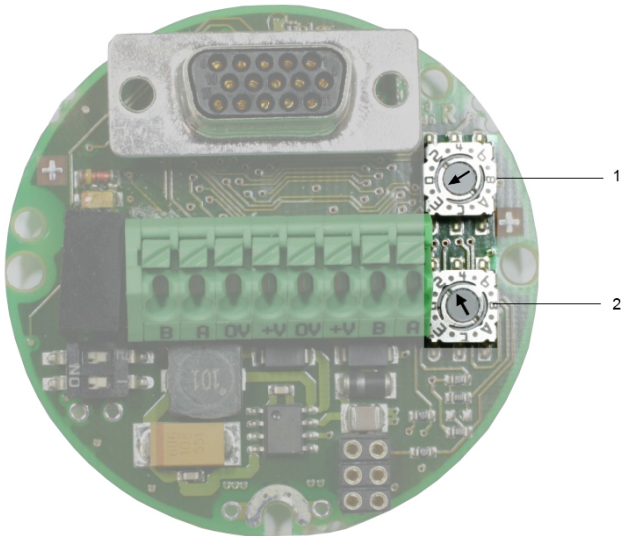

9007199344823051

- b) Put the bus cover back in place and connect the voltage supply.
- c) Set the station address to 0x7D (125 decimal).



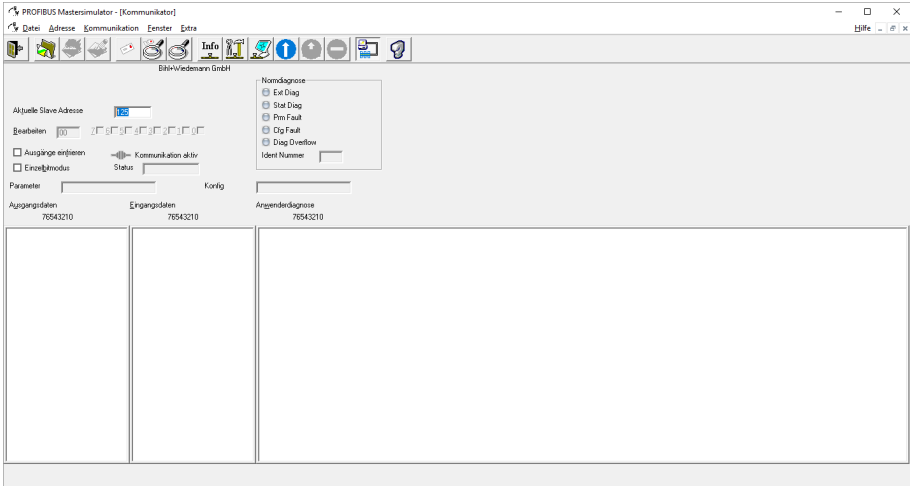

106363787

## Writing the configuration in the control.

- ✓ Master / slave connection The device is now recognized under station address 125.

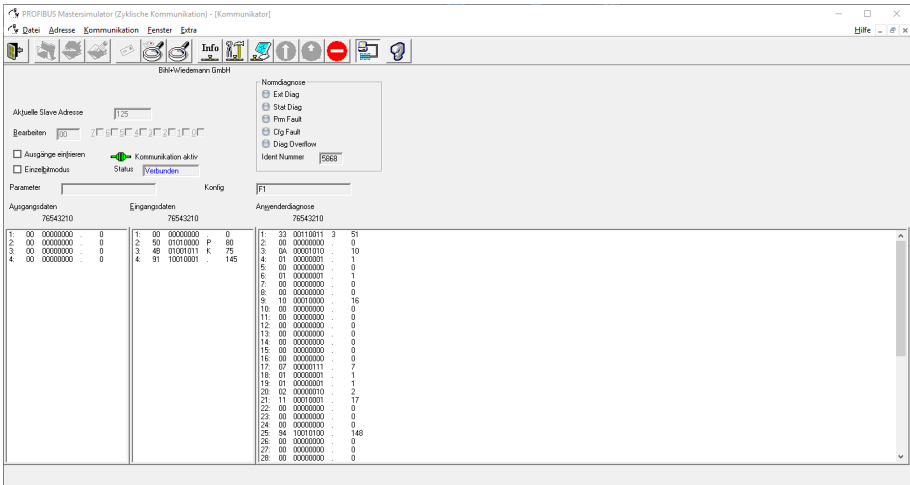

106361867

a) Disconnect the master / slave connection and change the station address to 0x0A (10 decimal).

b) Write the configuration in the control.

- ⇒ Mater / slave connection with new station address 10. The device is now recognized under station address 10.

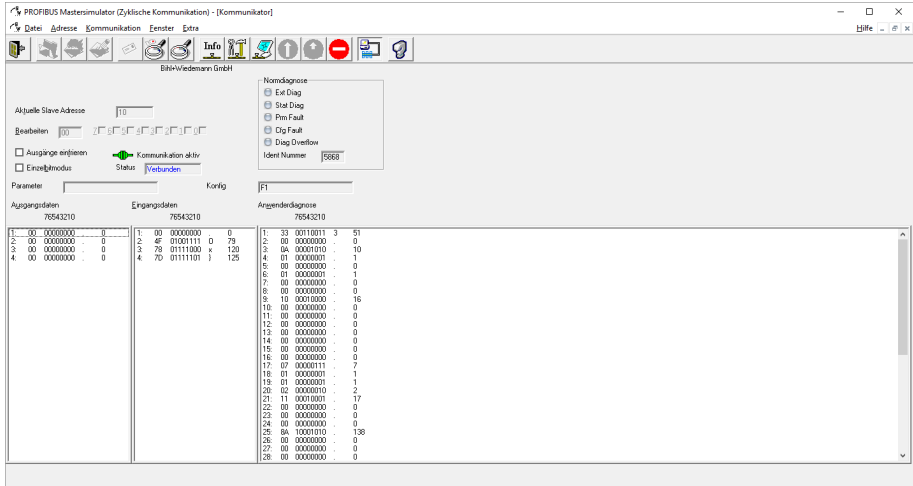

## 5.5.2 Performing a Preset

✓ This example sets preset 100 decimal, which is subsequently performed.

a) Enter preset value 0x64 in the output word.

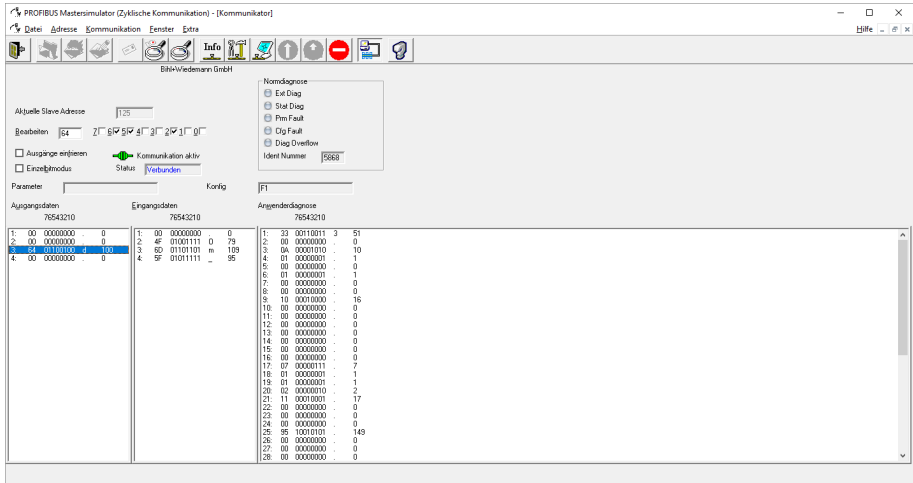

106358027

b) Enter trigger bit 1 in the MSB of the output word in byte 0.

c) Perform the preset

⇒ The current position value changes to 100 decimal.

⇒ The device outputs a warning message.

**NOTICE**

**Warning message when performing the preset.**

When performing the preset, the device issues a warning message, since the position can change suddenly by a large value. This is an intentional behavior and not an error.

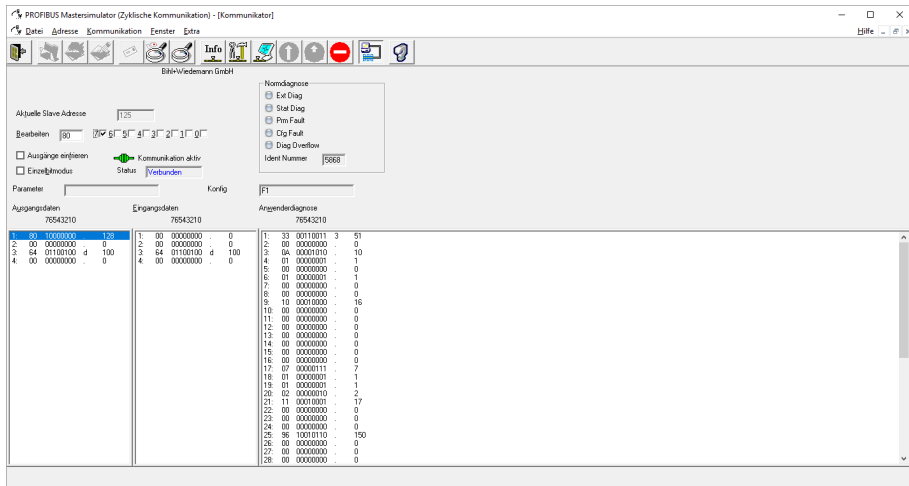

# 6 Annex

## 6.1 Extended Diagnostic

### Device profile Encoder

Class 1 mandatory for all DP encoders			
Function	Byte no.	Data Type	Name
Data_Exchange	1-4	Unsigned 32	Position Value (input)
Data_Exchange	1-4	Unsigned 32	Preset value (output)
Data_Exchange	1-4	Unsigned 32	Speed Value (input) (units/s)
RD_inp	1-4	Unsigned 32	Position Value
RD_inp	1-4	Unsigned 32	Speed Value
Slave_Diag	7	Octet String	External Diagnostic Header
Slave_Diag	8	Octet String	Alarms
Slave_Diag	9	Octet String	Operating Status
Slave_Diag	10	Octet String	Encoder Type
Slave_Diag	11-14	Unsigned 32	Singleturn Resolution
Slave_Diag	15, 16	Unsigned 16	Number or Revolution
Set_prm	9	Octet String	Operating Parameters
Class 2 optional functionality			
Function	Byte no.	Data Type	Name
Slave_Diag	17	Octet String	Additional Alarms
Slave_Diag	18, 19	Octet String	Supported Alarms
Slave_Diag	20, 21	Octet String	Warnings
Slave_Diag	22, 23	Octet String	Supported Warnings
Slave_Diag	24, 25	Octet String	Profile Version
Slave_Diag	26, 27	Octet String	Software Version
Slave_Diag	28-31	Unsigned 32	Operating Time
Slave_Diag	32-35	Signed 32	Offset Value
Slave_Diag	36-39	Signed 32	Manufacturer Offset Value
Slave_Diag	40-43	Unsigned 32	Measuring Units per Revolution
Slave_Diag	44-47	Unsigned 32	Total measuring range in measuring units
Slave_Diag	48-57	ASCII String	Serial Number
Set_prm	10-13	Unsigned 32	Measuring Units per Revolution
Set_prm	14-17	Unsigned 32	Total measuring range in measuring units

## 6.2 Service Access Point (SAP)

PROFIBUS defines various services, which must not mandatorily be implemented. The SAPs are defined with their respective number.

SAP (Decimal)	SERVICE
Default 0	Cyclical Data Exchange (Write_Read_Data)
54	Master-to-Master SAP (M-M Communication)
55	Change Station Address (Set_Slave_Add)
56	Read Inputs (Rd_Inp)
57	Read Outputs (Rd_Outp)
58	Control Commands to a DP Slave (Global_Control)
59	Read Configuration Data (Get_Cfg)
60	Read Diagnostic Data (Slave_Diagnosis)
61	Send Parameterization Data (Set_Prm)
62	Check Configuration Data (Chk_Cfg)

<b>NOTICE</b>	<b>SAP55 is optional</b>
	SAP55 is optional and can be locked if the slave has no non-volatile memory for the participant address.

### 6.3 Decimal / Hexadecimal conversion table

Dec	Hex	Dec	Hex	Dec	Hex	Dec	Hex	Dec	Hex
0	0	51	33	102	66	153	99	204	CC
1	1	52	34	103	67	154	9A	205	CD
2	2	53	35	104	68	155	9B	206	CE
3	3	54	36	105	69	156	9C	207	CF
4	4	55	37	106	6A	157	9D	208	D0
5	5	56	38	107	6B	158	9E	209	D1
6	6	57	39	108	6C	159	9F	210	D2
7	7	58	3A	109	6D	160	A0	211	D3
8	8	59	3B	110	6E	161	A1	212	D4
9	9	60	3C	111	6F	162	A2	213	D5
10	0A	61	3D	112	70	163	A3	214	D6
11	0B	62	3E	113	71	164	A4	215	D7
12	0C	63	3F	114	72	165	A5	216	D8
13	0D	64	40	115	73	166	A6	217	D9
14	0E	65	41	116	74	167	A7	218	DA
15	0F	66	42	117	75	168	A8	219	DB
16	10	67	43	118	76	169	A9	220	DC
17	11	68	44	119	77	170	AA	221	DD
18	12	69	45	120	78	171	AB	222	DE
19	13	70	46	121	79	172	AC	223	DF
20	14	71	47	122	7A	173	AD	224	E0
21	15	72	48	123	7B	174	AE	225	E1
22	16	73	49	124	7C	175	AF	226	E2
23	17	74	4A	125	7D	176	B0	227	E3
24	18	75	4B	126	7E	177	B1	228	E4
25	19	76	4C	127	7F	178	B2	229	E5
26	1A	77	4D	128	80	179	B3	230	E6
27	1B	78	4E	129	81	180	B4	231	E7
28	1C	79	4F	130	82	181	B5	232	E8
29	1D	80	50	131	83	182	B6	233	E9
30	1E	81	51	132	84	183	B7	234	EA

<b>Dec</b>	<b>Hex</b>	<b>Dec</b>	<b>Hex</b>	<b>Dec</b>	<b>Hex</b>	<b>Dec</b>	<b>Hex</b>	<b>Dec</b>	<b>Hex</b>
31	1F	82	52	133	85	184	B8	235	EB
32	20	83	53	134	86	185	B9	236	EC
33	21	84	54	135	87	186	BA	237	ED
34	22	85	55	136	88	187	BB	238	EE
35	23	86	56	137	89	188	BC	239	EF
36	24	87	57	138	8A	189	BD	240	F0
37	25	88	58	139	8B	190	BE	241	F1
38	26	89	59	140	8C	191	BF	242	F2
39	27	90	5A	141	8D	192	C0	243	F3
40	28	91	5B	142	8E	193	C1	244	F4
41	29	92	5C	143	8F	194	C2	245	F5
42	2A	93	5D	144	90	195	C3	246	F6
43	2B	94	5E	145	91	196	C4	247	F7
44	2C	95	5F	146	92	197	C5	248	F8
45	2D	96	60	147	93	198	C6	249	F9
46	2E	97	61	148	94	199	C7	250	FA
47	2F	98	62	149	95	200	C8	251	FB
48	30	99	63	150	96	201	C9	252	FC
49	31	100	64	151	97	202	CA	253	FD
50	32	101	65	152	98	203	CB	254	FE
								255	FF

# Glossary

**ccw**

---

counterclockwise, counting direction

**cw**

---

clockwise, counting direction

**DTE**

---

Data Terminal Equipment

**HEX**

---

Hexadecimal

**LSB**

---

Least Significant Bit

**MSB**

---

Most Significant Bit

**MUR**

---

Measuring Units per Revolution

**NDR**

---

Number of Distinguishable Revolutions

**PNO**

---

Profibus Nutzerorganisation (Profibus Users Organization)

**Profibus DP**

---

Profibus Decentralized Periphery

**Profibus FMS**

---

Profibus Fieldbus Message Specification

**rpm**

---

Rounds per Minute

**SAP**

---

Service Access Point

**SSA**

---

Set Slave Address

**TMR**

---

Total Measuring Range